

WROUGHT STEEL GROOVED END FITTINGS

The **Shurjoint** wrought steel grooved end fittings are available 10" (250 mm) through 42" (1050 mm) pipe sizes in a variety of styles. Fittings are fabricated from standard weight (0.375" or 9.5 mm) carbon steel pipe to ASTM A234 Gr. WPB or equivalent grade, or segmentally welded with carbon steel standard weight pipe. C-E dimensions conform to ANSI B16.9. Other styles not listed are available upon request.

Fittings are painted orange or red, or as an option can be supplied hot-dip galvanized or epoxy coated.



Full warranty terms can be found on www.shurjoint.com

MODELS W110LR 90° ELBOW, L/R
W111LR 45° ELBOW
W120 Tee
W160 Cap

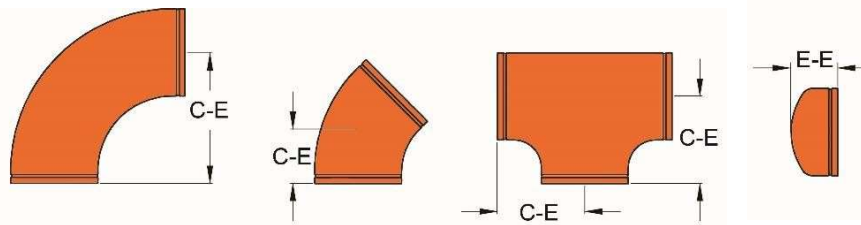

W110LR

W111LR

W120

W160

Models W110LR / W111LR / W120 / W160 Wrought Steel Grooved End Fittings

Nominal Pipe Size	Pipe O.D.	W110LR 90° L/R Elbows		W111LR 45° Elbows		W120 Tee		W160 Cap	
		C-E	Weight	C-E	Weight	C-E	Weight	E-E	Weight
in	in	in	Lbs	in	Lbs	in	Lbs	in	Lbs
mm	mm	mm	Kgs	mm	Kgs	mm	Kgs	mm	Kgs
10	10.750	15.000	78.0	6.25	39.0	---	---	---	---
250	273.0	381.0	35.4	158.8	17.7	---	---	---	---
12	12.750	18.000	114.6	7.50	57.3	---	---	---	---
300	323.9	457.2	52.0	190.5	26.0	---	---	---	---
14	14.000	21.00	149.4	8.75	74.8	11.00	110.2	6.50	35.0
350	355.6	533.4	67.9	222.3	34.0	279.4	50.0	165.0	15.9
16	16.000	24.00	195.8	10.00	98.1	12.00	145.4	7.00	44.0
400	406.4	609.6	89.0	254.0	44.6	304.8	66.1	178.0	20.0
18	18.000	27.00	248.6	11.25	124.3	13.50	169.8	8.00	56.1
450	457.2	685.8	113.0	285.5	56.5	342.9	77.0	203.0	25.5
20	20.000	30.00	308.0	12.50	154.0	15.00	209.4	9.00	70.0
500	508.0	762.0	140.0	317.5	70.0	381.0	95.0	229.0	31.8
22	22.000	33.00	371.8	13.50	187.0	16.50	277.2	10.00	85.4
550	558.8	838.2	169.0	342.9	85.0	419.1	126.0	254.0	38.8
24	24.000	36.00	444.4	15.00	222.2	17.00	267.9	10.50	99.2
600	609.6	914.4	202.0	381.0	101.0	431.8	121.5	267.0	45.1
26	26.000	39.00	103.6	16.00	51.7	19.50	71.5	10.50	24.3
650	660.4	990.6	228.5	406.4	114.0	495.3	157.6	267.0	53.5
28	28.000	42.00	120.1	17.25	59.9	20.50	80.1	10.50	26.9
700	711.0	1066.8	264.7	438.2	132.1	520.7	176.6	267.0	59.3
30	30.000	45.00	137.7	18.50	68.8	22.00	92.0	10.50	29.6
750	762.0	1143.0	303.6	469.9	151.6	558.8	202.9	267.0	65.2
32	32.000	48.00	156.5	19.75	78.2	23.50	104.8	10.50	32.3
800	812.8	1219.2	345.1	501.7	172.4	596.9	231.0	267.0	71.3

Models W110LR / W111LR / W120 / W160 Wrought Steel Grooved End Fittings

Nominal Pipe Size	Pipe O.D.	W110LR 90° L/R Elbows		W111LR 45° Elbows		W120 Tee		W160 Cap	
		C-E	Weight	C-E	Weight	C-E	Weight	E-E	Weight
in	in	in	Lbs	in	Lbs	in	Lbs	in	Lbs
mm	mm	mm	Kgs	mm	Kgs	mm	Kgs	mm	Kgs
34	34.000	51.00	176.6	21.00	88.2	25.00	118.4	10.50	35.2
850	863.6	1295.4	389.3	533.4	194.6	635	260.9	267.0	77.7
36	36.000	54.00	197.8	22.25	98.9	26.50	132.8	10.50	38.2
900	914.4	1371.6	436.1	565.2	218.1	673.1	292.7	267.0	84.2
40	40.000	60.00	244.2	24.88	122.7	29.50	164.0	12.00	47.8
1000	1016.0	1524.0	538.4	632.0	270.6	749.3	361.6	304.8	105.4
42	42.000	63.00	269.1	26.00	134.6	30.00/28.00	167.6	12.00	51.2
1050	1066.8	1600.2	593.2	660.4	296.7	762.0/711.2	369.5	304.8	113.0

MODEL W121 WROUGHT REDUCING TEE

Material: Fabricated with ASTM A234 Gr. WPB, standard weight (0.375" or 9.5 mm), or segmentally welded carbon steel of the same or equivalent grade.

C-E & C-B dimensions: conform to ANSI B16.9

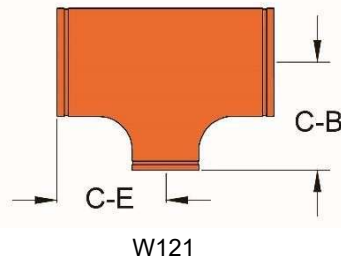
Model W121 Wrought Reducing Tee

Nominal Pipe Size	Pipe O.D.	W121 Reducing Tee			Nominal Pipe Size	Pipe O.D.	W121 Reducing Tee		
		C-E	C-B	Weight			C-E	C-B	Weight
in	in	in / mm	in / mm	Lbs / Kgs	in	in	in / mm	in / mm	Lbs / Kgs
mm	mm				mm	mm			
14 x 6	14.000 x 6.625	11.0	9.37	101.2	26 x 18	26.000 x 18.000	19.50	17.50	317.9
350 x 150	355.6 x 168.3	279.0	238.0	46.0	650 x 450	660.4 x 457.2	495	444	144.5
14 x 8	14.000 x 8.625	11.0	9.76	102.3	26 x 20	26.000 x 20.000	19.50	18.00	320.1
350 x 200	355.6 x 219.1	279.0	248.0	46.5	650 x 500	660.4 x 508.0	495	457	145.9
14 x 10	14.000 x 10.750	11.0	10.12	104.9	28 x 12	28.000 x 12.750	20.50	17.62	356.8
350 x 250	355.6 x 273.0	279.0	257.0	47.7	700 x 300	711.0 x 323.9	521	448	162.2
14 x 12	14.000 x 12.750	11.0	10.63	96.8	28 x 14	28.000 x 14.000	20.50	18.00	356.8
350 x 300	355.6 x 323.9	279.0	270.0	44.0	700 x 350	711.0 x 355.6	521	457	162.2
16 x 6	16.000 x 6.625	12.0	10.40	125.8	28 x 16	28.000 x 16.000	20.50	18.00	356.8
400 x 150	406.4 x 168.3	305.0	264.0	57.2	700 x 400	711.0 x 406.4	521	457	162.2
16 x 8	16.000 x 8.625	12.0	10.75	127.2	28 x 18	28.000 x 18.000	20.50	18.50	358.6
400 x 200	406.4 x 219.1	305.0	273.0	57.8	700 x 450	711.0 x 457.2	521	470	163.0
16 x 10	16.000 x 10.750	12.0	11.14	129.6	28 x 20	28.000 x 20.000	20.50	19.00	361.5
400 x 250	406.4 x 273.0	305.0	283.0	58.9	700 x 500	711.0 x 508.0	521	483	164.3
16 x 12	16.000 x 12.750	12.0	11.61	132.2	28 x 22	28.000 x 22.000	20.50	19.50	364.8
400 x 300	406.4 x 323.9	305.0	295.0	60.1	700 x 550	711.0 x 559.0	521	495	165.8
16 x 14	16.000 x 14.000	12.0	12.00	134.4	28 x 24	28.000 x 24.000	20.50	20.00	368.9
400 x 350	406.4 x 355.6	305.0	308.0	61.1	700 x 600	711.0 x 609.6	521	508	167.7
18 x 6	18.000 x 6.625	13.5	11.38	159.7	30 x 16	30.000 x 16.000	22.00	19.00	409.0
450 x 150	457.2 x 168.3	343.0	289.0	72.6	750 x 400	762.2 x 406.4	559	483	185.5
18 x 8	18.000 x 8.625	13.5	11.75	160.6	30 x 18	30.000 x 18.000	22.00	19.50	411.0
450 x 200	457.2 x 219.1	343.0	298.0	73.0	750 x 450	762.2 x 457.2	559	495	186.8
18 x 10	18.000 x 10.750	13.5	12.13	162.8	30 x 20	30.000 x 20.000	22.00	20.00	413.6
450 x 250	457.2 x 273.0	343.0	308.0	74.0	750 x 500	762.2 x 508.0	559	508	188.0
18 x 12	18.000 x 12.750	13.5	12.64	165.2	30 x 22	30.000 x 22.000	22.00	20.50	416.9
450 x 300	457.2 x 323.9	343.0	321.0	75.1	750 x 550	762.2 x 559.0	559	521	189.5
18 x 14	18.000 x 14.000	13.5	13.00	167.2	30 x 24	30.000 x 24.000	22.00	21.00	420.6
450 x 350	457.2 x 355.6	343.0	330.0	76.0	750 x 610	762.2 x 609.6	559	533	191.2
18 x 16	18.000 x 16.000	13.5	13.00	167.9	30 x 28	30.000 x 28.000	22.00	21.50	425.9
450 x 400	457.2 x 406.4	343.0	330.0	76.3	750 x 700	762.2 x 711.0	559	546	193.6
20 x 6	20.000 x 6.625	15.0	12.36	196.9	32 x 20	32.000 x 20.000	23.50	21.00	469.7

Model W121 Wrought Reducing Tee

Nominal Pipe Size	Pipe O.D.	W121 Reducing Tee			Nominal Pipe Size	Pipe O.D.	W121 Reducing Tee		
		C-E	C-B	Weight			C-E	C-B	Weight
in	in	in / mm	in / mm	Lbs / Kgs	in	in	in / mm	in / mm	Lbs / Kgs
500 x 150	508.0 x 168.3	381.0	314.0	89.5	800 x 500	813.0 x 508.0	597	533	213.5
20 x 8	20.000 x 8.625	15.0	12.76	198.0	32 x 22	32.000 x 22.000	23.50	21.50	472.6
500 x 200	508.0 x 219.1	381.0	324.0	90.0	800 x 550	813.0 x 559.0	597	546	214.8
20 x 10	18.000 x 10.750	15.0	13.11	200.0	32 x 24	32.000 x 24.000	23.50	22.00	476.0
500 x 250	508.0 x 273.0	381.0	333.0	90.9	800 x 600	813.0 x 609.6	597	559	216.4
20 x 12	20.000 x 12.750	15.0	13.62	202.4	32 x 28	32.000 x 28.000	23.50	22.50	480.9
500 x 300	508.0 x 323.9	381.0	346.0	92.0	800 x 700	813.0 x 711.0	597	572	218.6
20 x 14	20.000 x 14.000	15.0	14.02	204.4	32 x 30	32.000 x 30.000	23.50	23.00	486.2
500 x 350	508.0 x 355.6	381.0	356.0	92.9	800 x 750	813.0 x 762.0	597	584	221.0
20 x 16	20.000 x 16.000	15.0	14.02	204.6	36 x 22	36.000 x 22.000	26.50	23.50	595.8
500 x 400	508.0 x 406.4	381.0	356.0	93.6	900 x 550	914.0 x 559.0	673	597	270.8
20 x 18	20.000 x 18.000	15.0	14.50	207.9	36 x 24	36.000 x 24.000	26.50	24.00	598.8
500 x 450	508.0 x 457.2	381.0	368.0	94.5	900 x 600	914.0 x 609.6	673	610	272.2
24 x 6	24.000 x 6.625	17.0	14.38	268.4	36 x 28	36.000 x 28.000	26.50	24.50	602.6
600 x 150	609.6 x 168.3	432.0	365.0	122.0	900 x 700	914.0 x 711.0	673	622	273.9
24 x 8	24.000 x 8.625	17.0	14.76	270.6	36 x 30	36.000 x 30.000	26.50	25.00	607.2
600 x 200	609.6 x 219.1	432.0	375.0	123.0	900 x 750	914.0 x 762.0	673	635	276.0
24 x 10	24.000 x 10.750	17.0	15.12	271.0	36 x 32	36.000 x 32.000	26.50	25.50	612.5
600 x 250	609.6 x 273.0	432.0	384.0	123.2	900 x 800	914.0 x 813.0	673	648	278.4
24 x 12	24.000 x 12.750	17.0	15.63	273.2	40 x 24	40.000 x 24.000	29.50	26.00	736.3
600 x 300	609.6 x 323.9	432.0	397.0	124.2	1000 x 600	1016.0 x 609.6	749	660	334.7
24 x 14	24.000 x 14.000	17.0	16.00	275.0	40 x 28	40.000 x 28.000	29.50	26.50	739.6
600 x 350	609.6 x 355.6	432.0	406.0	125.0	1000 x 700	1016.0 x 711.0	749	673	336.2
24 x 16	24.000 x 16.000	17.0	16.00	275.0	40 x 30	40.000 x 30.000	29.50	27.50	748.2
600 x 400	609.6 x 406.4	432.0	406.0	125.0	1000 x 750	1016.0 x 762.0	749	698	340.1
24 x 18	24.000 x 18.000	17.0	16.50	279.6	42 x 24	42.000 x 24.000	30.00	26.00	778.1
600 x 450	609.6 x 457.2	432.0	419.0	127.1	1050 x 600	1067.0 x 609.6	762	660	353.7
24 x 20	24.000 x 20.000	17.0	17.00	281.6	42 x 28	42.000 x 28.000	30.00	27.50	788.0
600 x 500	609.6 x 508.0	432.0	432.0	128.0	1050 x 700	1067.0 x 711.0	762	698	358.2
26 x 10	26.000 x 10.750	19.50	16.60	314.4	42 x 30	42.000 x 30.000	30.00	28.00	792.0
650 x 250	660.4 x 273.0	495	422	142.9	1050 x 750	1067.0 x 762.0	762	711	360.0
26 x 12	26.000 x 12.750	19.50	16.60	315.3	42 x 32	42.000 x 32.000	30.00	28.00	791.6
650 x 300	660.4 x 323.9	495	422	143.3	1050 x 800	1067.0 x 813.0	762	711	359.8
26 x 14	26.000 x 14.000	19.50	17.00	315.9	42 x 36	42.000 x 36.000	30.00	28.00	791.1
650 x 350	660.4 x 355.6	495	432	143.6	1050 x 900	1067.0 x 914.0	762	711	359.6
26 x 16	26.000 x 16.000	19.50	17.00	315.9	42 x 40	42.000 x 40.000	30.00	28.00	791.1
650 x 400	660.4 x 406.4	495	432	143.6	1050 x 1000	1067.0 x 1016.0	762	711	359.6

**MODELS W150 WROUGHT CONCENTRIC REDUCER
W151 WROUGHT ECCENTRIC REDUCER**

Material: Fabricated with ASTM A234 Gr. WPB, standard weight (0.375" or 9.5 mm), or segmentally welded carbon steel of the same or equivalent grade.

E-E dimensions: conform to ANSI B16.9.

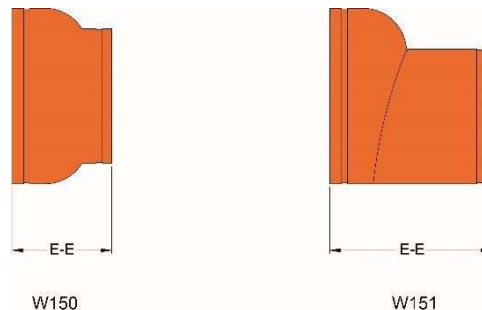
Models W150 Wrought Concentric Reducer / W151 Wrought Eccentric Reducer

Nominal Pipe Size	Pipe O.D.	W150 Concentric Reducer		W151 Eccentric Reducer	
		E-E	Weight	E-E	Weight
in	in	in / mm	Lbs / Kgs	in / mm	Lbs / Kgs
14 x 6	14.000 x 6.625	13.00	67.76	13.00	67.76

Models W150 Wrought Concentric Reducer / W151 Wrought Eccentric Reducer

Nominal Pipe Size	Pipe O.D.	W150		W151	
		Concentric Reducer		Eccentric Reducer	
		E-E	Weight	E-E	Weight
in mm	in mm	in / mm	Lbs / Kgs	in / mm	Lbs / Kgs
350 x 150	355.6 x 168.3	330.0	30.8	330.0	30.8
14 x 8	14.000 x 8.625	13.00	69.96	13.00	69.96
350 x 200	355.6 x 219.1	330.0	31.8	330.0	31.8
14 x 10	14.000 x 10.750	13.00	71.94	13.00	71.94
350 x 250	355.6 x 273.0	330.0	32.7	330.0	32.7
14 x 12	14.000 x 12.750	13.00	73.92	13.00	73.92
350 x 300	355.6 x 323.9	330.0	33.6	330.0	33.6
16 x 8	16.000 x 8.625	14.00	87.78	14.00	87.78
400 x 200	406.4 x 219.1	356.0	39.9	356.0	39.9
16 x 10	16.000 x 10.750	14.00	90.86	14.00	90.86
400 x 250	406.4 x 273.0	356.0	41.3	356.0	41.3
16 x 12	16.000 x 12.750	14.00	92.84	14.00	92.84
400 x 300	406.4 x 323.9	356.0	42.2	356.0	42.2
16 x 14	16.000 x 14.000	14.00	94.82	14.00	94.82
400 x 350	406.4 x 355.6	356.0	43.1	356.0	43.1
18 x 10	18.000 x 10.750	15.00	111.76	15.00	111.76
450 x 250	457.2 x 273.0	381.0	50.8	381.0	50.8
18 x 12	18.000 x 12.750	15.00	114.84	15.00	114.84
450 x 300	457.2 x 323.9	381.0	52.2	381.0	52.2
18 x 14	18.000 x 14.000	15.00	117.70	15.00	117.70
450 x 350	457.2 x 355.6	381.0	53.5	381.0	53.5
18 x 16	18.000 x 16.000	15.00	120.78	15.00	120.78
450 x 400	457.2 x 406.4	381.0	54.9	381.0	54.9
20 x 12	20.000 x 12.750	20.00	159.72	20.00	159.72
500 x 300	508.0 x 323.9	508.0	72.6	508.0	72.6
20 x 14	20.000 x 14.000	20.00	163.68	20.00	163.68
500 x 350	508.0 x 355.6	508.0	74.4	508.0	74.4
20 x 16	20.000 x 16.000	20.00	167.64	20.00	167.64
500 x 400	508.0 x 406.4	508.0	76.2	508.0	76.2
20 x 18	20.000 x 18.000	20.00	171.60	20.00	171.6
500 x 450	508.0 x 457.2	508.0	78.0	508.0	78.0
24 x 16	24.000 x 16.000	20.00	197.56	20.00	197.56
600 x 400	609.6 x 406.4	508.0	89.8	508.0	89.8
24 x 18	24.000 x 18.000	20.00	199.54	20.00	199.54
600 x 450	609.6 x 457.2	508.0	90.7	508.0	90.7
24 x 20	24.000 x 20.000	20.00	203.50	20.00	203.50
600 x 500	609.6 x 508.0	508.0	92.5	508.0	92.5
28 x 18	28.000 x 18.000	24.00	191.80	24.00	191.80
700 x 450	711.2 x 457.2	610.0	87.0	610.0	87.0

MODEL W130 45° LATERAL

Material: Fabricated with ASTM A234 Gr. WPB, standard weight (0.375" or 9.5 mm), or segmentally welded carbon steel of the same or equivalent grade.

C-LE and C-SE dimensions: manufacturer's standard.

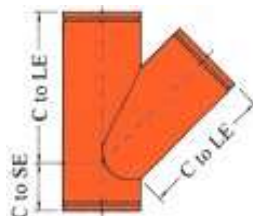

Model W130 45° Lateral

Nominal Pipe Size	Pipe O.D.	C-LE	C-SE	Weight
in mm	in mm	in mm	in mm	Lbs Kgs
14 350	14.000 355.6	26.5 673	7.5 191	219.14 99.4
16 400	16.000 406.4	29.0 737	8.0 203	270.5 122.7
18 450	18.000 457.2	32.0 813	8.5 216	332.7 150.9
20 500	20.000 508.0	35.0 889	9.0 229	401.3 182.0
24 600	24.000 609.6	40.0 1016	10.0 254	541.3 245.5
28 700	28.0 711.0	44.0 1118	11.0 279	934.0 423.7
30 750	30.0 762.0	46.0 1169	11.5 292	1048.0 475.2
32 800	32.0 813.0	48.0 1219	12.0 305	1167.0 529.5
36 900	36.0 914.0	52.0 1321	13.0 330	1423.6 645.7
40 1000	40.0 1016.0	56.0 1422	14.0 356	1706.0 773.8
42 1050	42.0 1067.0	58.0 1473	14.5 368	1857.0 842.1

MODEL W131 45° REDUCING LATERAL

Material: Fabricated with ASTM A234 Gr. WPB, standard weight (0.375" or 9.5 mm), or segmentally welded carbon steel of the same or equivalent grade.

C-LE and C-SE dimensions: manufacturer's standard.

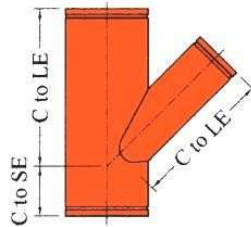
Model W131 Reducing Lateral

Nominal Pipe Size	Pipe O.D.	C-LE	C-SE	Weight
in mm	in mm	in mm	in mm	Lbs Kgs
14 x 14 x 4 350 x 350 x 100	14.000 x 14.000 x 4.500 355.6 x 355.6 x 114.3	26.5 673	7.5 191	175.9 79.8
14 x 14 x 6 350 x 350 x 150	14.000 x 14.000 x 6.625 355.6 x 355.6 x 168.3	26.5 673	7.5 191	185.9 84.3
14 x 14 x 8 350 x 350 x 200	14.000 x 14.000 x 8.625 355.6 x 355.6 x 219.1	26.5 673	7.5 191	195.0 88.4
14 x 14 x 10 350 x 350 x 250	14.000 x 14.000 x 10.750 355.6 x 355.6 x 273.0	26.5 673	7.5 191	204.4 92.7
14 x 14 x 12 350 x 350 x 300	14.000 x 14.000 x 12.750 355.6 x 355.6 x 323.9	26.5 673	7.5 191	213.3 96.8
16 x 16 x 6 400 x 400 x 150	16.000 x 16.000 x 6.625 406.4 x 406.4 x 168.3	29.0 737	8.0 203	226.4 102.7
16 x 16 x 8 400 x 400 x 200	16.000 x 16.000 x 8.625 406.4 x 406.4 x 219.1	29.0 737	8.0 203	236.0 107.1
16 x 16 x 10 400 x 400 x 250	16.000 x 16.000 x 10.750 406.4 x 406.4 x 273.0	29.0 737	8.0 203	246.0 111.6
16 x 16 x 12 400 x 400 x 300	16.000 x 16.000 x 12.750 406.4 x 406.4 x 323.9	29.0 737	8.0 203	255.1 115.7

**Model W131 Reducing Lateral**

Nominal Pipe Size	Pipe O.D.	C-LE	C-SE	Weight
in mm	in mm	in mm	in mm	Lbs Kgs
16 x 16 x 14 400 x 400 x 350	16.000 x 16.000 x 14.000 406.4 x 406.4 x 355.6	29.0 737	8.0 203	260.9 118.4
18 x 18 x 6 450 x 450 x 150	18.000 x 18.000 x 6.625 457.2 x 457.2 x 168.3	32.0 813	8.5 216	274.8 124.6
18 x 18 x 8 450 x 450 x 200	18.000 x 18.000 x 8.625 457.2 x 457.2 x 219.1	32.0 813	8.5 216	285.3 129.4
18 x 18 x 12 450 x 450 x 300	18.000 x 18.000 x 12.750 457.2 x 457.2 x 323.9	32.0 813	8.5 216	306.2 138.9
18 x 18 x 14 450 x 450 x 350	18.000 x 18.000 x 14.000 457.2 x 457.2 x 355.6	32.0 813	8.5 216	312.4 141.7
18 x 18 x 16 450 x 450 x 400	18.000 x 18.000 x 16.000 457.2 x 457.2 x 406.4	32.0 813	8.5 216	322.4 146.2
20 x 20 x 12 500 x 500 x 300	20.000 x 20.000 x 12.750 508.0 x 508.0 x 323.9	35.0 889	9.0 229	362.1 164.3
20 x 20 x 14 500 x 500 x 350	20.000 x 20.000 x 14.000 508.0 x 508.0 x 355.6	35.0 889	9.0 229	368.7 167.2
20 x 20 x 16 500 x 500 x 400	20.000 x 20.000 x 16.000 508.0 x 508.0 x 406.4	35.0 889	9.0 229	379.4 172.1
24 x 24 x 16 600 x 600 x 400	24.000 x 24.000 x 16.000 609.6 x 609.6 x 406.4	40.0 1016	10.0 254	494.9 224.5
24 x 24 x 20 600 x 600 x 500	24.000 x 24.000 x 20.000 609.6 x 609.6 x 508.0	40.0 1016	10.0 254	517.7 234.8
28 x 28 x 18 700 x 700 x 450	28.000 x 28.000 x 18.000 711.0 x 711.0 x 457.2	44.0 1117	11.0 279	767 347.8
28 x 28 x 20 700 x 700 x 500	28.000 x 28.000 x 20.000 711.0 x 711.0 x 508.0	44.0 1117	11.0 279	796 361.2
28 x 28 x 24 700 x 700 x 600	28.000 x 28.000 x 24.000 711.0 x 711.0 x 609.6	44.0 1117	11.0 279	855 388.0
30 x 30 x 18 750 x 750 x 450	30.000 x 30.000 x 18.000 762.2 x 762.2 x 457.2	46.0 1168	11.5 292	840.3 381.1
30 x 30 x 20 750 x 750 x 500	30.000 x 30.000 x 20.000 762.2 x 762.2 x 508.0	46.0 1168	11.5 292	871 395.2
30 x 30 x 24 750 x 750 x 610	30.000 x 30.000 x 24.000 762.2 x 762.2 x 609.6	46.0 1168	11.5 292	933 423.2
32 x 32 x 20 800 x 800 x 500	32.000 x 32.000 x 20.000 813.0 x 813.0 x 508.0	48.0 1219	12.0 305	950 430.6
32 x 32 x 24 800 x 800 x 600	32.000 x 32.000 x 24.000 813.0 x 813.0 x 609.6	48.0 1219	12.0 305	1014 459.8
32 x 32 x 30 800 x 800 x 750	32.000 x 32.000 x 30.000 813.0 x 813.0 x 762.0	48.0 1219	12.0 305	1110 503.4
36 x 36 x 24 900 x 900 x 600	36.000 x 36.000 x 24.000 914.0 x 914.0 x 609.6	52.0 1320	13.0 330	1185 537.3
36 x 36 x 30 900 x 900 x 750	36.000 x 36.000 x 30.000 914.0 x 914.0 x 762.0	52.0 1320	13.0 330	1289 584.5
36 x 36 x 32 900 x 900 x 800	36.000 x 36.000 x 32.000 914.0 x 914.0 x 813.0	52.0 1320	13.0 330	1324 600.3
40 x 40 x 24 1000 x 1000 x 600	40.000 x 40.000 x 24.000 1016.0 x 1016.0 x 609.6	56.0 1422	14.0 356	1370 621.3
40 x 40 x 30 1000 x 1000 x 750	40.000 x 40.000 x 30.000 1016.0 x 1016.0 x 762.0	56.0 1422	14.0 356	1482 672.1
40 x 40 x 36 1000 x 1000 x 900	40.000 x 40.000 x 36.000 1016.0 x 1016.0 x 914.0	56.0 1422	14.0 356	1594 722.9
42 x 42 x 24 1050 x 1050 x 600	42.000 x 42.000 x 24.000 1067.0 x 1067.0 x 609.6	58.0 1473	14.5 368	1467 665.5
42 x 42 x 30 1050 x 1050 x 750	42.000 x 42.000 x 30.000 1067.0 x 1067.0 x 762.0	58.0 1473	14.5 368	1583 718.2
42 x 42 x 36 1050 x 1050 x 900	42.000 x 42.000 x 36.000 1067.0 x 1067.0 x 914.0	58.0 1473	14.5 368	1699 770.8

MODEL W135 CROSS MODEL W137 TRUE WYE

Material: Fabricated with ASTM A234 Gr. WPB, standard weight (0.375" or 9.5 mm), or segmentally welded carbon steel of the same or equivalent grade.

C-LE and C-SE dimensions: manufacturer's standard.

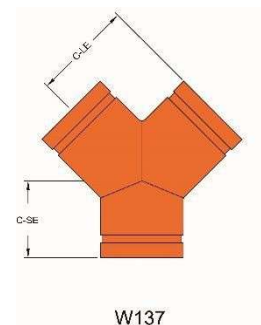
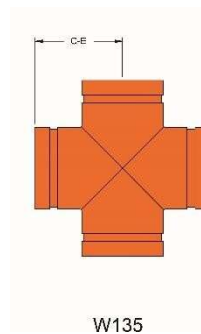

Model W135 Cross / W137 True Wye						
Nominal Pipe Size	Pipe O.D.	W135 Cross		W137 True Wye		
		C-E	Weight	C-LE	C-SE	Weight
in	in	in / mm	Lbs / Kgs	in / mm	in / mm	Lbs / Kgs
mm	mm					
14	14.000	11.00	121.0	11.00	7.50	98.0
350	355.6	279	54.9	279	191	44.4
16	16.000	12.00	146.4	12.00	8.00	119.3
400	406.4	305	66.4	305	203	54.1
18	18.000	13.50	185.4	13.50	8.50	148.3
450	457.2	343	84.1	343	216	67.3
20	20.000	15.00	229.1	15.00	9.00	180.4
500	508.0	381	103.9	381	229	81.8
24	24.000	17.00	298.7	17.00	10.00	238.3
600	609.6	432	135.5	432	254	108.1

MODEL W170 FLANGE ADAPTER ANSI CLASS 125 / 150

The Model W170 Flange Adapter fabricated in sizes 10" ~ 42" provide a direct connection to ANSI Class 125/150 flanges. Dimensions of NPS 10" ~ NPS 24" conform to ANSI/ASME B16.5. Dimensions of NPS 26" ~ NPS 42" conform to ANSI/ASME B16.47.

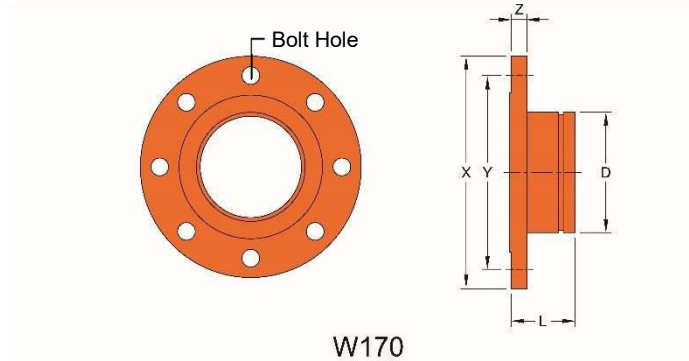

Model W170 Flange Adapter ANSI Class 125/150

Nominal Pipe Size	X	Y	Z	Bolt Size	Bolt Hole		D	L	Weight
					Dia.	No.			
in <i>mm</i>	in <i>ØBmm</i>	in <i>mm</i>	in <i>mm</i>	in	in	No.	in <i>mm</i>	in <i>mm</i>	Lbs <i>Kgs</i>
10 250	16.00 406.4	14.25 362.0	1.18 30.0	¾	1	12	10.75 273.0	5.00 127.0	9.9 21.9
12 300	19.00 483.0	17.00 432.0	1.25 32.0	¾	1	12	12.75 323.9	5.00 127.0	14.1 31.1
14 350	21.00 533.0	18.75 476.3	1.38 35.0	1	1½	12	14.00 355.6	5.00 127.0	18.1 40.0
16 400	23.50 597.0	21.25 539.7	1.46 37.0	1	1½	16	16.00 406.4	5.00 127.0	22.2 49.0
18 450	25.00 635.0	22.75 577.8	1.57 40.0	1½	1¼	16	18.00 457.2	5.50 140.0	25.2 55.6
20 500	27.50 699.0	25.00 635.0	1.69 43.0	1½	1¼	20	20.00 508.0	6.00 152.0	31.1 68.6
24 600	32.00 813.6	29.50 749.3	1.89 48.0	1¼	1½	20	24.00 609.6	6.00 152.0	42.1 92.8
26 650	34.25 870.0	31.75 806.4	2.63 66.7	1¼	1½	24	26.00 660.4	8.00 203.0	63.6 140.3
28 700	36.50 925.0	34.00 863.6	2.75 69.9	1¼	1½	28	28.00 711.0	8.00 203.0	72.2 159.2
30 750	38.75 985.0	36.00 914.4	2.88 73.1	1¼	1½	28	30.00 762.0	8.00 203.0	81.1 178.8
32 800	41.75 1060.0	38.50 977.9	3.13 79.4	1½	1½	28	32.00 812.8	9.00 228.6	281.9 621.4
34 850	43.75 1110.0	40.50 1028.7	3.19 81.0	1½	1½	32	34.00 863.6	9.00 228.6	112.4 247.8
36 900	46.00 1170.0	42.75 1085.8	3.50 88.9	1½	1½	32	36.00 914.4	9.00 228.6	131.7 290.5
40 1000	50.75 1290.0	47.25 1200.2	3.50 88.9	1½	1½	36	40.00 1016.0	10.00 254.0	158.6 349.7
42 1050	53.00 1345.0	49.50 1257.3	3.75 95.3	1½	1½	36	42.00 1066.8	10.00 254.0	180.5 398.0

MODEL W170 FLANGE ADAPTER - PN 10/16

The Model W170 Flange Adapter fabricated in sizes 10" ~ 40" (250 mm ~ 1000 mm) provide a direct connection to PN 10/16 flanges. Dimensions conform to BS EN 1092.

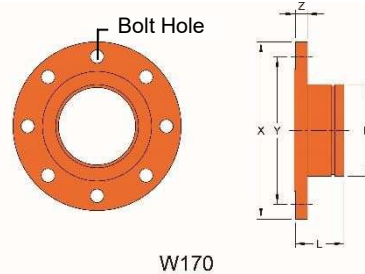

Model W170 Flange Adapter - PN 10

Nominal Pipe Size	X	Y	Z	Bolt Size	BoltHole		D	L	Weight
					Dia.	No.			
mm	mm	mm	mm		mm		mm	mm	Kgs
250	395.0	350.0	26	M20	22.0	12	273.0	114.0	18.2
300	445.0	400.0	26	M20	22.0	12	323.9	114.0	21.4
350	505.0	460.0	30	M20	22.0	16	355.6	127.0	31.1
400	565.0	515.0	32	M24	26.0	16	406.4	127.0	38.1
450	615.0	565.0	36	M24	26.0	20	457.0	152.0	48.2
500	670.0	620.0	38	M24	26.0	20	508.0	152.0	56.4
600	780.0	725.0	42	M27	30.0	20	610.0	152.0	74.0
700	895.0	840.0	50	M27	30.0	24	711.0	178.0	107.9
800	1015.0	950.0	56	M30	33.0	24	813.0	190.0	148.3
900	1115.0	1050.0	62	M30	33.0	28	914.0	190.0	174.5
1000	1230.0	1160.0	70	M33	36.0	28	1016.0	215.0	229.2

Model W170 Flange Adapter - PN 16

Nominal Pipe Size	X	Y	Z	Bolt Size	BoltHole		D	L	Wt.
					Dia.	No.			
mm	mm	mm	mm		mm		mm	mm	Kgs
250	405.0	355.0	29	M24	26.0	12	273.0	114	20.4
300	460.0	410.0	32	M24	26.0	12	323.9	114	26.5
350	520.0	470.0	35	M24	26.0	16	355.6	140	38.1
400	580.0	525.0	38	M27	30.0	16	406.4	140	47.2
450	640.0	585.0	42	M27	30.0	20	457.0	165	61.4
500	715.0	650.0	46	M30	33.0	20	508.0	165	80.4
600	840.0	770.0	55	M33	36.0	20	610.0	190	123.8
700	910.0	840.0	63	M33	36.0	24	711.0	200	138.3
800	1025.0	950.0	74	M36	39.0	24	813.0	240	198.0
900	1125.0	1050.0	82	M36	39.0	28	914.0	215	227.9
1000	1255.0	1170.0	90	M39	42.0	28	1016.0	240	311.4

General Notes:

- **Pressure Ratings** for fittings conform to the working pressure of the coupling used to join the system.
- **Field Joint Test:** For one time only the system may be tested hydrostatically at 1½ times the maximum working pressure listed (AWWA C606 5.2.3).
- **Warning:** Piping systems must always be depressurized and drained before attempting disassembly and/or removal of any components.
- **The 10 Year Limited Warranty** applies to manufacturing defects only and does not cover severe service/temperature applications or wear parts.
- **Shurjoint** reserves the right to change specifications, designs and or standard without notice and without incurring any obligations.